

Interactive 3D graphic, click to activate and rotate.
(3D capable PDF viewer required)

Technical Details	
Part Number	ES8X2CIRTBK
Series	E-Line Series
Mounting Options	Swivel Caster
Wheel Diameter [INCH]	8.000
Tread Width [INCH]	2
Tread Type	Cast Iron
Mount Height [INCH]	9 1/2
Swivel Radius [INCH]	6 1/4
Wheel Bearing	Roller
Caster Brake	Tread Lock Brake
Capacity [lbs]	1250

Your Caster, Wheel & Material Handling Solutions Provider

Caster Central is the leading caster and wheel provider for all your mobility and handling needs. With over 150 years in business, we understand the need for reliable mobility solutions. No matter the application, we have high-quality solution for your company's use.

Thanks to our devoted team, we have provided clients with top-quality caster solutions for years. Our customers receive the best solutions for their needs and suitable recommendations from skilled professionals.

Standard Features

- Budget focused family of 2" wide casters and wheels
- Mass-inventoried with a large variety of size, wheel, brake, and accessory options
- 1/4" thick steel leg construction
- Double ball bearing raceways
- 5/8" diameter permanent rivet kingpin
- RoHS compliant industrial zinc finish
- 1/2" axle with grease zerck and lock nut
- NSF listed on select models

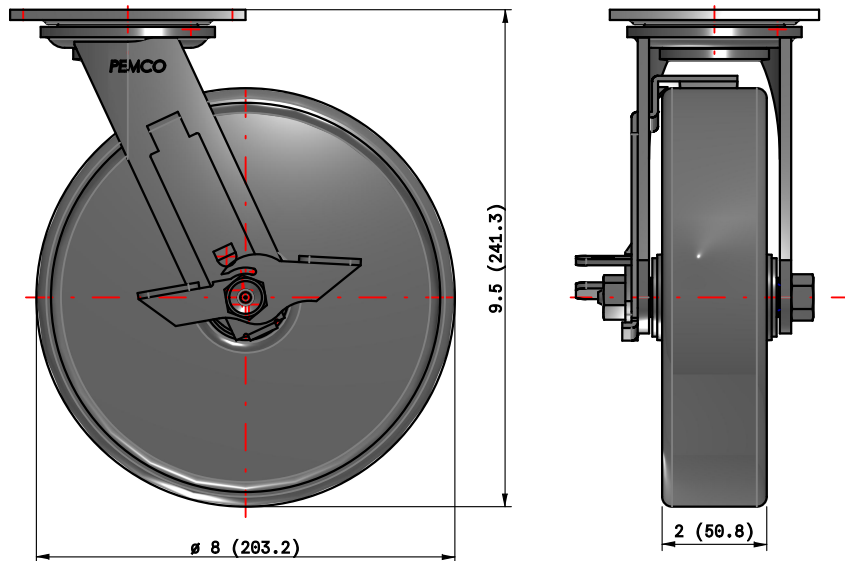
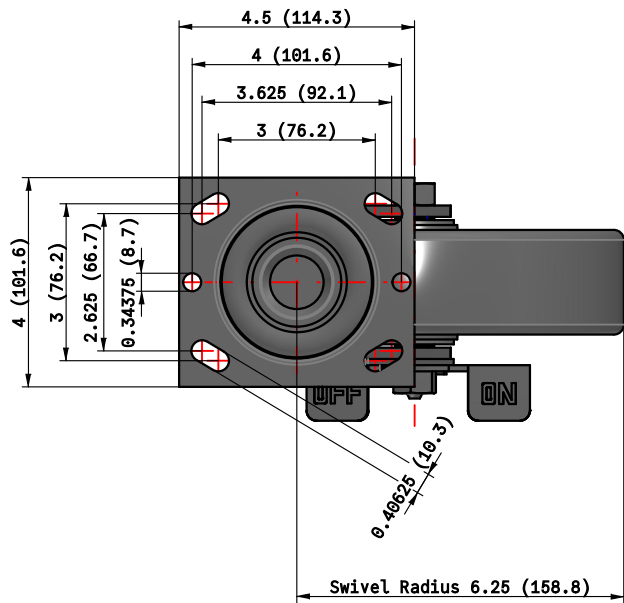

Part Number:

ES8X2CIRTBK

Series:

E-Line

Brand:

W.T. Hight

Caster Central

div. of W.T. Hight Company
42 Winter Street, Suite 18
Pembroke, MA 02359
800-445-4082
www.castercentral.com
www.wthight.com