

SSU10



Super Smart ball bearings, inch

SSU, Ball Bushing Bearing, 0.625, Self-Aligning, Closed, Not Corrosion Resistant, No Wipers

Lead Time: Next Day

\$43.64 each[†]

- These universally self-aligning bearings offer twice the load capacity or eight times the travel life of our Super Ball Bushing[®] bearing.
- Its unique design with the steel band enables the bearing to preserve its ID fit-up and self-aligning capability over extended use.
- A universal self-alignment feature optimizes load distribution between ball tracks and assures uniform ball loading over the entire length of the bearing plate.
- This patented product provides smooth, quiet, low drag linear movement at 6x the load capacity or 216 x the L10 travel life of a conventional steel linear ball bushing bearing.

[†]The price shown here is the North American List Price for general reference only. Please Contact Thomson for actual net price and current delivery schedule which will vary with geographic region, quantity ordered and distribution channel. Estimated costs for shipping, packaging and import taxes/duty are not included in this list price. Please contact Thomson Customer Support for more information.

Dimensions

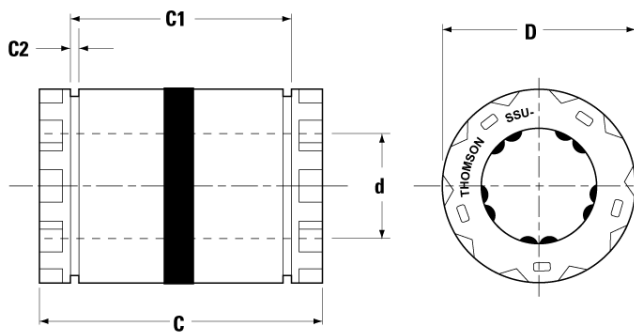

Dimension	Value
C	38.10 mm (1.500 in)
C1	28.58 mm (1.125 in)
C2	1.40 mm (0.055 in)
d	15.88 mm (0.625 in)
D	28.58 mm (1.125 in)

Specifications

Specifications	Value
Adjustable/Not Adjustable	Not Adjustable
Closed/Open	Closed
Number of Ball Circuits	10
Roll Pack	No Roll Pack

Specifications	Value
Food Grade Rated	Not Food Grade
Self Alignment	Self-aligning
Single/Twin	Single
Temperature Max	85 °C / 185 °F
Use with shafting class	L
Wipers, Seals	
Weight	0.054 kg / 0.12 lbs
Nominal Diameter	15.875 mm / 0.625 in
Outer Diameter	28.575 mm / 1.125 in
Length	38.100 mm / 1.5 in

Performance

Load Correction Factor, K_{θ}

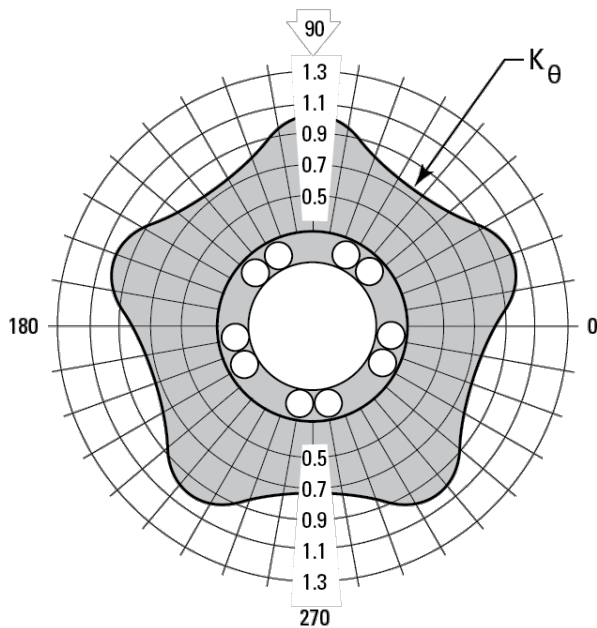

The actual dynamic load capacity of a Ball Bushing Bearing is determined by the direction of the applied load relative to the bearing circuits. The load correction factor K is found by referring to the polar graph. To determine the actual dynamic load capacity, multiply the proper correction factor (K) by the dynamic load capacity.

Performance	Value
Load Capacity, Dynamic	2,757.897 N / 620 lbf

Travel Life

The following formula may be used to determine travel life for bearings with imperial units:

$$L_m = \left(\frac{W}{P} \cdot K_\theta \cdot K_s \right)^3 \cdot 2 \cdot 10^6 \text{ inches}$$

Where: L_m = travel life (in)
 W = dynamic load capacity rating (lbf)
 P = resultant from externally applied loads (lbf)
 K_θ = load correction factor
 K_s = shaft hardness factor

Shaft Hardness factor, K_s

For shafts that do not meet hardness 60 HRC, shaft hardness factor K_s must be applied.

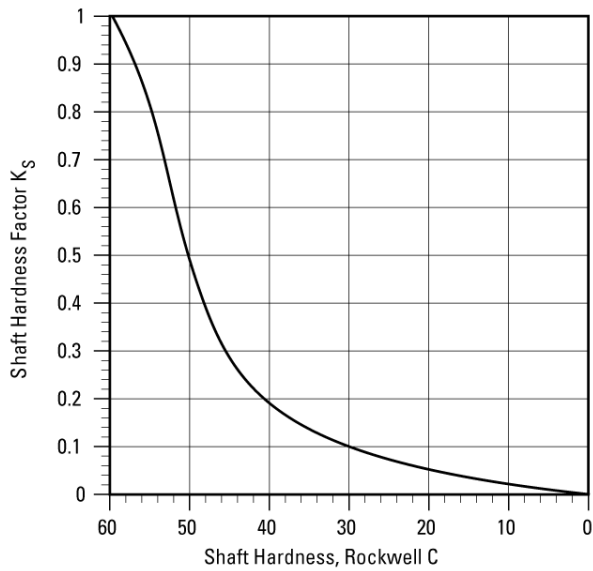

Order Code

SSU16WW-CR

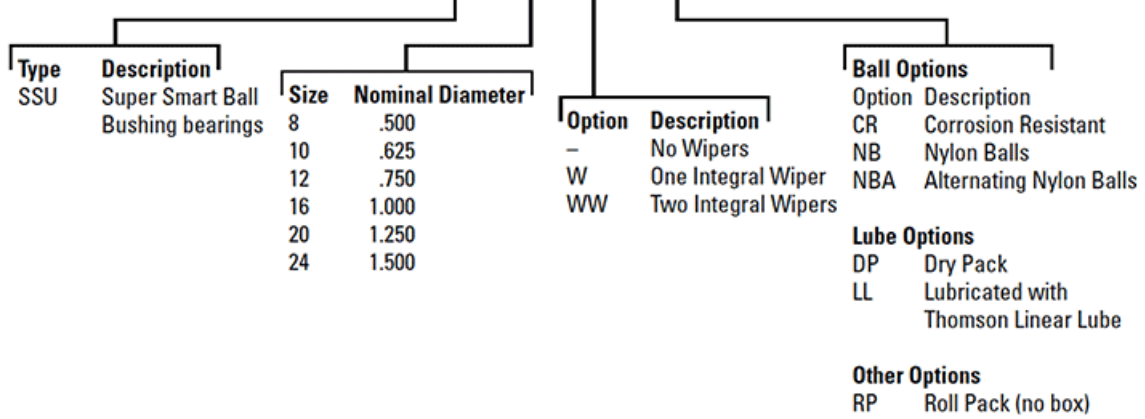

Related Products



5/8 L CTL

5/8" Shafting, L Class, Cut to Length

<https://www.thomsonlinear.com/en/product/5/8 L CTL>